

No.	PART NAME	QTY	MATERIAL
1	METAL FRAME	1	SUS304
2	LASER WARNING LABEL	1	COATED PAPER
3	SHUTTER	1	PC/ABS
4	SPRING PIN	1	SUS304
5	TORSION SPRING	1	SUS304
6	CAPS	1	PP
7	CLIP	1	SUS304
8	HOUSING	2	PC/ABS
9	SLEEVE HOLDER	2	PBT
10	SLEEVE	1	ZIRCONIA

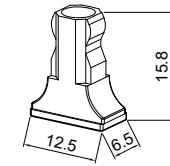

MATERIA: PBT OR PP
K3.FS01.0601

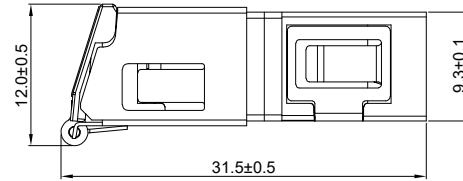
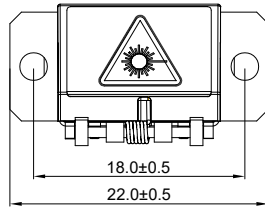
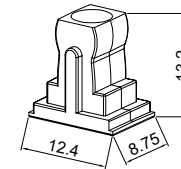

MATERIA: PBT OR PP
K3.FS03.0603

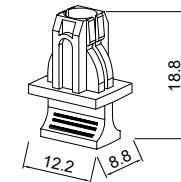

MATERIA: PP
K3.FS04.0604

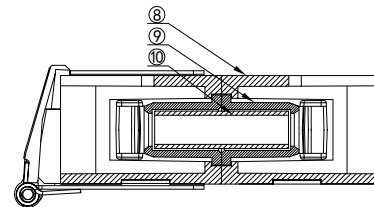
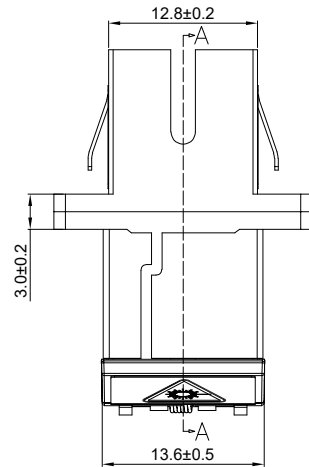

SECTION A-A

OPTIONAL ATTACHMENT

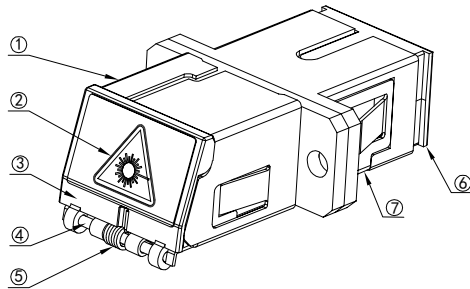

TECHNICAL REQUIREMENT:

- 1.COMPLIES WITH IEC 61754-4 AND TIA-604-3
- 2.COMPLIES WITH IEC-60874-14-3 AND IEC-60874-14-4
- 3.COMPLIES WITH IEC 61753-1 CATEGORY (C)
- 4.COMPLIES WITH ROHS, REACH REQUIREMENTS

NOTES
1.ALL DIMENSIONS WITHOUT TOLERANCE ARE FOR REFERENCE ONLY.

2.DUST CAPS ARE SHOWN IN ISOMETRIC VIEWS ONLY.

DIMENSION UNITS	SCALE	CURRENT REV DESC:	
MM	1:1		
GENERAL TOLERANCES (UNLESS SPECIFIED)			
ANGULAR TOL ± °			
X	± 0.2	DRWN: JHK	2024/05/25
X.X	± 0.1	CHK'D: CHENEY	2024/05/26
X.XX	± 0.05	APPR: JACK	2024/11/26
X.XXX	± 0.003	INITIAL REVISION:	
X°	± 2°	DRWN: CHENEY	2012/03/11
X.X°	± 1°	APPR: JACK	2012/03/26
DRAFT WHERE APPLICABLE MUST REMAIN WITHIN DIMENSIONS		THIRD ANGLE PROJECTION	DRAWING A-SIZE
			CUSTOMER 00101



SC SIMPLEX ADAPTER-WITH FLANGE
(METAL FRAME SHUTTER)

PRODUCT DRAWING

DOCUMENT NUMBER	DOC TYPE	DOC PART	DREVISION
K2.SC1JF21.00101	PDF	M001	A/2

MATERIAL NUMBER	CUSTOMER	SHEET NUMBER
SEE TABLE	GENERAL MARKET	1 OF 1